

SPECIFICATION

Model: **RB1-G500HP**

Redundant Power Supply

Active PFC

500W + 500W

80+ Gold Efficiency

PMBus 1.2

| | | |
|---------|---------|---------|
| Approve | Check | Prepare |
| Brian | Richard | Vincent |

Release History

| Rev. | Description | Date | Name |
|-------------|------------------------|-------------|-------------|
| X01 | Initial draft release. | 2014/12/05 | Vincent |
| X02 | Modify model name | 2014/12/09 | Vincent |
| A | The final version | 2015/01/15 | Vincent |
| | | | |
| | | | |
| | | | |
| | | | |
| | | | |
| | | | |
| | | | |
| | | | |
| | | | |
| | | | |
| | | | |
| | | | |
| | | | |
| | | | |
| | | | |
| | | | |
| | | | |
| | | | |
| | | | |
| | | | |
| | | | |
| | | | |
| | | | |
| | | | |
| | | | |
| | | | |
| | | | |
| | | | |
| | | | |
| | | | |

Contents

| | | |
|-----|--|----|
| 1. | General | 5 |
| 2. | AC input pacifications | 5 |
| 2.1 | AC input voltage, frequency and current | 5 |
| 2.2 | AC inrush current | 6 |
| 2.3 | Input power factor correction (Active PFC) | 6 |
| 2.4 | Input current harmonics | 6 |
| 2.5 | Drop out | 6 |
| 3. | DC output specification | 7 |
| 3.1 | Output current / loading | 7 |
| 3.2 | DC voltage regulation, ripple and noise | 7 |
| 3.3 | Timing requirements | 8 |
| 3.4 | Remote On/Off control PSON# | 9 |
| 3.5 | Efficiency | 10 |
| 3.6 | +5VSB (Standby) | 10 |
| 4. | Protection | 11 |
| 4.1 | Over power protection | 11 |
| 4.2 | Over voltage protection | 11 |
| 4.3 | Over current protection | 11 |
| 4.4 | Short circuit protection | 12 |
| 5. | Environmental requirements | 12 |
| 5.1 | Temperature | 12 |
| 5.2 | Humidity | 12 |
| 6. | Agency requirement | 12 |
| 6.1 | Safety certification | 12 |
| 6.2 | AC input leakage current | 12 |
| 7. | Redundant power supply function | 13 |
| 7.1 | Redundancy | 13 |
| 7.2 | Hot swap requirements | 13 |
| 7.3 | LED indicators | 14 |
| 8. | PMBus (Option) | 14 |
| 8.1 | PMBus communication | 14 |
| 8.2 | Power supply management interface | 14 |
| 8.3 | PMBus signal connector | 17 |

| | | |
|------|--|----|
| 9. | Reliability | 18 |
| 9.1 | Mean Time Between failures (MTBF) | 18 |
| 9.2 | Warranty | 18 |
| 10. | Physical characteristics size | 19 |
| 10.1 | Dimension: 168mm(W) x 41.5mm(H) x 230mm(D) | 19 |
| 10.2 | DC Output Wire | 20 |
| 10.3 | Module PIN Assignment | 21 |

1. General

This is the specification of Model RB1-G500HP; it is intended to describe the functions and performance of the redundant power supply. The RB1-G500HP 500 watts redundant power supply is featured with Active PFC (Power Factor Correction) capability and gold efficiency for 80+ and PMBus function meets IEC61000-3-2 and equips full range Input features.

Base on the KINTRON Product coding rule, you could quickly figure out the description by following:

1 2 3 4 5 6 7
R **B** **1** - **G** **500** **H** **P**

1. Power type: M: mini redundant, R: redundant, S: single, U: unit/module.
2. Size type: From A to Z and each one has its own dimension.
3. Height/PS2: for redundant power mean the height of the set 1: 1U, 2: 2U, 3: 3U, 4: 4U, P: PS2.
4. Efficiency: Base on 80+ definition, B: Bronze, S: Silver, G: Gold, P: Platinum, T: Titanium.
5. DC output watt: The total power for power supply and use three digit as naming, 550: 550W, 600: 600W, A00:1000W, B00:1100W... etc.
6. Application dimension: H: Horizontal, V: Vertical.
7. PMBus: P: with PMBus, N: without PMBus.

2. AC input specifications

2.1 AC input voltage, frequency and current

(Rating: 100V-240 VAC, 47-63Hz, 8.5-4A)

The power supply must operate within all specified limits over the input voltage range in Table 1. Harmonics distortion of up to 10% THD must not cause the power supply to go out of specified limits.

Base on the minimum voltage and power transfer, the max current calculation as below:

$$\text{Max Current} \geq (\text{Watt} / \text{Efficiency}) / \text{Minimum Voltage}$$

| Parameter | Minimum | Normal | Maximum | Max. Current |
|----------------|---------|-------------|---------|--------------|
| Voltage (115V) | 90 VAC | 100-120 VAC | 132 VAC | 8.5A |
| Voltage (230V) | 180 VAC | 200-240 VAC | 264 VAC | 4A |
| Frequency | 47 Hz | 50 / 60 Hz | 63 Hz | N/A |

Table 1 – AC Input Voltage and Frequency

2.2 AC inrush current

The power supply must meet inrush requirements of any rated AC voltage, during turn on at any phase of voltage, during a single cycle AC dropout condition, during repetitive On/Off cycling of AC, and over the specified temperature range. The peak inrush current shall be 30/60A @ 115/230 VAC (25°C) per module when cold start and less than the rating of its critical components (including input fuse, bulk rectifiers, and surge limiting device).

2.3 Input power factor correction (Active PFC)

The power factor at 50% load shall be ≥ 0.9 at 230V input voltage.

2.4 Input current harmonics

When the power supply is operated in 90-264 VAC of Sec. 2.1, the input harmonic current drawn on the power line shall not exceed the limits set by IEC61000-3-2 Class A and GB17625.1 standards. The power supply shall incorporate universal power input with active power factor correction.

2.5 Dropout

An AC line dropout of 17mS or less shall not cause any tripping of control signals or protection circuits. If the AC dropout lasts longer than 17mS, the power supply should recover and meet all turn on requirements. The power supply shall meet the regulation requirement over all rated AC voltages, frequencies, and output loading conditions. Any dropout of the AC line shall not cause damage to the power supply. An AC line dropout is defined as a drop in AC line to 0 VAC at any phase of the AC line for any length of time.

3. DC output specification

3.1 Output current / loading

The following table defines power and current rating. The power supply shall meet both static and dynamic voltage regulation requirements for minimum load condition.

| | | | | | |
|----------------|------|-------|------|------|-------|
| Output Voltage | +5V | +3.3V | +12V | -12V | +5VSB |
| Max. Load | 24A | 24A | 41A | 0.8A | 3.5A |
| Min. Load | 1A | 1A | 1A | 0A | 0.1A |
| Max. Combined | 160W | | | 9.6W | 17.5W |
| Total Output | 500W | | | | |

Table 2 – Output Loads Range 1

Note 1: Maximum continuous total DC output power should not exceed 500W.

3.2 DC voltage regulation, ripple and noise

The power supply output voltages must stay within the following voltage limits when operating at steady state and dynamic loading conditions. All outputs are measured with reference to the return remote sense (Returns) signal. The +5V, +3.3V, +12V, -12V and +5VSB outputs are measure at the power supply connectors references to Returns. The +5V and +3.3V is measured at its remote sense signal (+5VS, +3.3VS) located at the signal connector.

| | | | | | |
|----------------|-------|-------|-------|-------|-------|
| Output Voltage | +5V | +3.3V | +12V | -12V | +5VSB |
| Load Reg. | +/-5% | +/-5% | +/-5% | +/-5% | +/-5% |
| Line Reg. | +/-1% | +/-1% | +/-1% | +/-1% | +/-1% |
| Ripple & Noise | 50mV | 50mV | 120mV | 120mV | 50mV |

Table 3 – Regulation, ripple and noise

Ripple and Noise shall be measured using the following methods:

- a) Measurements made differentially to eliminate common-mode noise.
- b) Ground lead length of oscilloscope probe shall be 0.25 inch.
- c) Measurements made where the cable connectors attach to the load.
- d) Outputs bypassed at the point of measurement with a parallel combination of 10uF tantalum capacitor in parallel with a 0.1uF ceramic capacitors.
- e) Oscilloscope bandwidth of 0 Hz to 20MHz.
- f) Measurements measured at locations where remote sense wires are connected.
- g) Regulation tolerance shall include temperature change, warm up drift and dynamic load.

3.3 Timing requirements

These are the timing requirements for the power assembly operation. The output voltages must rise from 10% to within regulation limits (T_{vout_rise}) within 5 to 70mS. The +5V, +3.3V and +12V output voltages should start to rise at about the same time. All outputs must rise monotonically. The +5V output must occur first than the +3.3V output during any point of the voltage rise. The +5V output must never be greater than the +3.3V output by more than 2.25V. Each output voltage shall reach regulation within 50 ms (T_{vout_on}) of each other during turn on of the power supply. Each output voltage shall fall out of regulation within 400 mS (T_{vout_off}) of each other during turn off. Figure 1 and figure 2 shows the turn on and turn off timing requirement. In Figure 2, the timing is shown with both AC and PSON# controlling the on/off of the power supply.

| Item | Description | MIN | MAX | Units |
|------------------|---|-----|-----|-------|
| T_{vout_rise} | Output voltage rise time from each main output.(+5Vsb < 70mS) | 5 | 70 | mS |
| T_{vout_on} | All main output must be within regulation of each other within this time. | N/A | 50 | mS |
| T_{vout_off} | All main output must leave regulation within this time | N/A | 400 | mS |

Table 4 – Output Voltage Timing

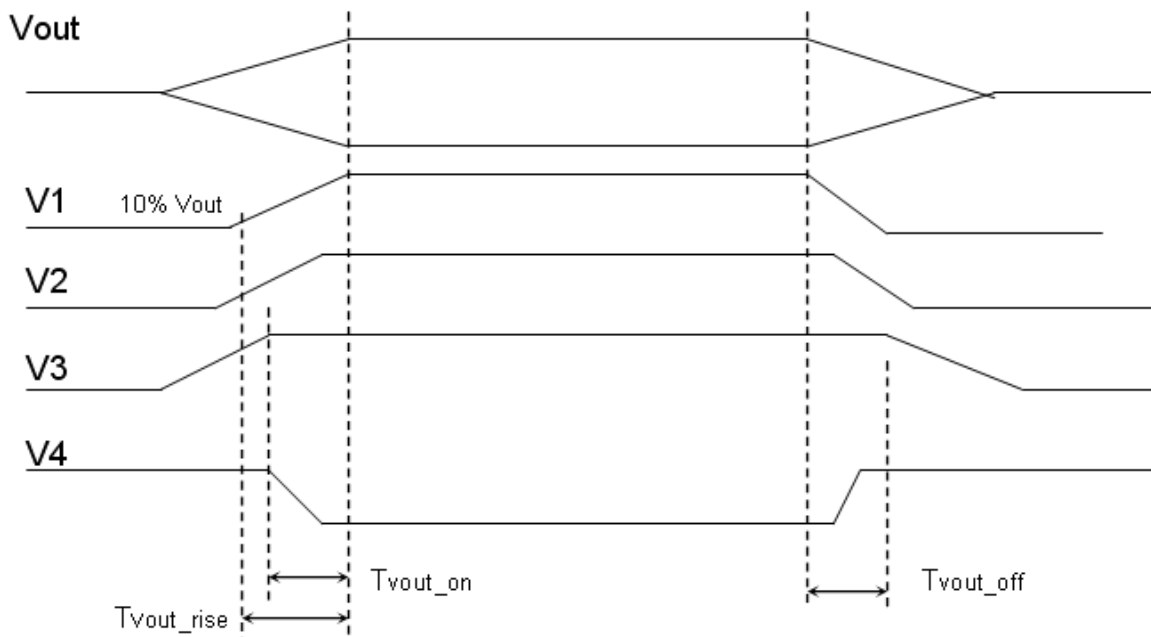

Figure 1 – Voltage Output Timing

| Item | Description | MIN | MAX | Units |
|----------------|---|-----|------|-------|
| Tsb_on-delay | Delay from AC being applied to +5VSB is being within regulation. | N/A | 1500 | mS |
| Tac_on-delay | Delay from AC being applied to all output voltages being Within regulation. | N/A | 2500 | mS |
| Tvout_holdup | All main output voltage stay within regulation after loss of AC | 18 | N/A | mS |
| Tpwok_holdup | Delay from loss of AC deassertion of PWOK. | 17 | N/A | mS |
| Tpson_on_delay | Delay from PSON# active to output voltage within regulation limits. | 5 | 400 | mS |
| Tpson_pwok | Delay from PSON# deactive to PWOK being deasserted. | N/A | 50 | mS |
| Tpwok_on | Delay from output voltage within regulation limits to PWOK asserted at turn on. | 100 | 500 | mS |
| Tpwok_off | Delay from PWOK deasserted to output voltages (+5V, +3.3V, +12V) dropping out of regulation limits. | 1 | N/A | mS |
| Tpwok_low | Duration of PWOK being in the deasserted state during an off/on cycle using AC or the PSON# signal. . | 100 | N/A | mS |
| Tsb_vout | Delay from +5VSB being in regulation to O/Ps being in regulation at AC turn on. | 50 | 1000 | mS |

Table 5 – Turn On/Off Timing

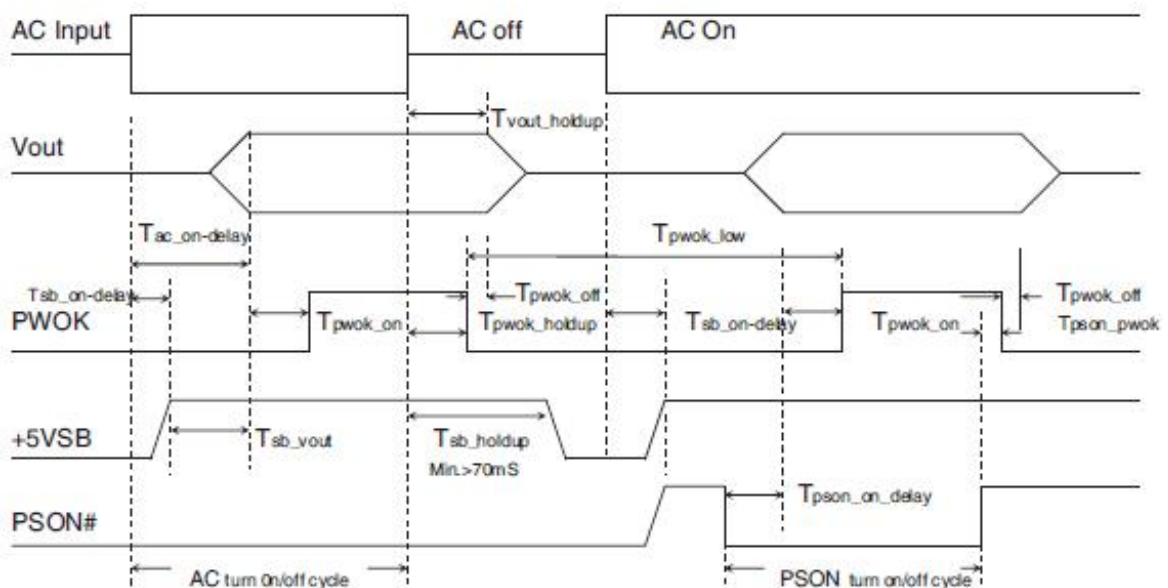

Figure 2 – Turn On/Off Timing

3.4 Remote On/Off Control: PSON#

The PSON# signal is required to remotely turn on/off the power supply. PSON# is an active low signal that turns on the +5V, +3.3V, +12V, -5V and -12V power rails. When this signal is not pulled low by the system, or left open, the outputs (except the +5VSB and V bias) turn off. This signal is pulled to a standby voltage by a pull-up resistor internal to the power supply.

| | |
|--------------|--|
| Signal Type | Accepts an open collector/drain input from the system. Pull-up to VSB located in power supply. |
| PSON# = Low | Power ON |
| PSON# = High | Power OFF |

Table 6 – PWOK Signal Characteristic

3.5 Efficiency (80+ Gold)

The efficiency should be measured module at 230 VAC and with external fan power source at specified loading.

| Input Voltage | 20% Load | 50% Load | 100% Load |
|---------------|----------|----------|-----------|
| 230 VAC | 88% | 92% | 88% |

Reference www.80plus.org all test conditions.

3.6 +5VSB (Standby)

The +5VSB output is always on (+5V Standby) when AC power is applied and power switch is turned on. The +5VSB line is capable of delivering at a maximum of 3A for PC board circuit to operate.

4. Protection

Protection circuits inside the power supply shall cause only the power supply's main outputs to shutdown. If the power supply latches off due to a protection circuit tripping, either an AC cycle OFF for 15 sec or PSON #cycle HIGH for 1 sec must be able to restart the power supply.

4.1 Over power protection

The OPP function shall work at 110%~160% of rating of output power, then all outputs shut down in a latch off mode. The latch shall be cleared by toggling the PSON# signal or by cycling the AC power. The power supply shall not be damaged from repeated power cycling in this condition. If only one module works inside the power supply, the OPP is at 110%~160% of rating of power supply.

4.2 Over voltage protection

Each hot swap module has respective OVP circuit. Once any power supply module shut down in a latch off mode while the output voltage exceeds the over voltage limit shown in Table 7, the other modules should deliver the sufficient power to the device continually.

| Voltage | Minimum | Maximum | Shutdown Mode |
|---------|---------|---------|---------------|
| +5V | +5.7V | +6.5V | Latch Off |
| +3.3V | +3.9V | +4.5V | Latch Off |
| +12V | +13.3V | +14.5V | Latch Off |
| 5VSB | +5.7V | +6.5V | Auto recovery |

Table 7 –Over Voltage protection

4.3 Over current protection

The power supply should contain the OCP function on each hot swap module. The power supply should be shut down in a latch off mode while the respective output current exceeds the limit as shown in Table 8. When the latch has been cleared by toggling the PSON# single or cycling the AC input power. The power supply module should not be damaged in this condition.

| Voltage | Minimum | Maximum | Shutdown Mode |
|---------|---------|---------|---------------|
| +5V | 110% | 170% | Latch Off |
| +3.3V | 110% | 170% | Latch Off |
| +12V | 110% | 170% | Latch Off |

Table 8 –Over Current protection

4.4 Short circuit protection

The power supply shall shut down in a latch off mode when the output voltage is short circuit.

5. Environmental requirements

5.1 Temperature

| | |
|----------------------------------|----------------------------|
| Operating Temperature Range: | 0°C ~ 45°C (32°F~ 113°F) |
| Non-Operating Temperature Range: | -20°C ~ 70°C (-4°F~ 158°F) |

5.2 Humidity

| | |
|-------------------------------|----------------------------|
| Operating Humidity Range: | 20% ~ 90%RH non-condensing |
| Non-Operating Humidity Range: | 5% ~ 95%RH non-condensing |

6. Agency requirements

6.1 Safety (Planning)

| | |
|-----------------|--|
| Product Safety: | <ul style="list-style-type: none"> UL60950-1/CSA 60950 (USA/Canada) TÜV (CB) IEC60950 (report to include all country national deviations) EN60950-1(Europe)/IEC60950-1(International) CCC- CNCA Certification (China) BSMI(Taiwan) FCC(USA) CE-low voltage directive 2006/95/EC(Europe) |
|-----------------|--|

6.2 AC Input leakage current

Input leakage current from line to ground will be less than 3.5mA rms. Measurement will be made at 240 VAC and 60Hz.

7. Redundant power supply function

7.1 Redundancy

The redundant power supply is N+1=N (500W+500W=500W) function power supply, each one module is redundancy when any one module was failed. To be redundant each item must be in the hot swap power supply module.

7.2 Hot swap requirements

The redundant power supply modules shall be hot swappable. Hot swapping a power supply is the process of inserting and extracting a power supply from an operating. During this process the output voltage shall remain within the limits specified in Table 7 with the capacitive load specified Table 9. The Sub-system shall not exceed the maximum inrush current as specified in section 2.2. The power supply can be hot swapped by the following methods:

AC connects with each module. Up to two power supplies may be on a single AC power source. Extraction: The AC power will be disconnected from the power supply first and then the power supply is extracted from the sub-system. This could occur in standby mode or powered on mode. Insertion: The module is inserted into the cage and then AC power will be connected to the power supply module.

For power modules with AC docking at the same time as DC. Extraction: The module is extracted from the cage and both AC and DC disconnect at the same Time. This could occur in standby or power on mode. No damage or arcing shall occur to the DC or AC contacts which could cause damage. Insertion: The AC and DC connect at the same time as the module is inserted into the cage. No damage to the connector contacts shall occur. The module may power on or come up into standby mode.

Many variations of the above are possible. Supplies need to be compatible with these different variations depending upon the sub-system construction. In general, a failed (off by internal latch or external control) supply may be removed, then replaced with a good power supply (must use the same model); however, hot swap needs to work with operational as well as failed power supplies. The newly inserted power supply may get turned on by inserting the supply into the system or by system management recognizing an inserted supply and explicitly turning it on.

7.3 LED Indicators

There is a single bi-color LED to indicate the power supply status. The Green LED turn ON to indicate that all the power outputs are available. The Orange LED (Green+Red) turn ON to indicate that the power supply has stand-by or failed shutdown due to over current, the Red LED turn ON to indicate the Fan of the power supply has failed. The LED(s) shall be visible on the exterior face of the power supply. The LED location shall meet ESD requirements. LED shall be securely mounted in such a way that incidental pressure on the LED shall not cause displaced.

8. PMBus

8.1 PMBus communication

The PMBus serial bus communication devices for I2C data in the power supply shall be compatible with both SMBus 2.0 “high power” and I2C Vdd based power and drive. This bus shall operate at 3.3V but tolerant of 5V signaling. The SMBus pull-ups are located on the motherboard and may be connected to 3.3V or 5V.

Two pins are allocated on the power supply. One pin is the serial clock (SMBus_SCL). The second pin is used for serial data (SMBus_SDA). Both pins are bi-directional and are used to form a serial bus.

The device(s) in the power supply shall be located at an address(s) determined by addressing pins A0 and A1 on the power supply module. The circuits inside the power supply shall derive their power from the 5VSB bus. Device(s) shall be powered from the system side of the 5VSB device. No pull-up resistors shall be on SCL or SDA inside the power supply. There pull-up resistors should be located external to the power supply.

8.2 Power supply management interface

The device in the power supply shall derive its power off of the 5VSB output on the system side. It shall be located at an address set by the A0 and A1 pins. Refer to the PMBus specification posted on the www.powerSIG.org website for details on the power supply monitoring interface requirements. I2C is a SMBus interface used to communicate power management information to the system.

8.2.1. Power supply management interface address

Device address locations

| | Housing | M1 | M2 |
|----------------------|---------|-----|-----|
| PDB addressing A1/A0 | | 1/1 | 0/1 |
| Device Address | | B0h | B2h |

8.2.2. PMBus command code summary

8.2.2. PMBus command code summary

PMBus Revision1.2 specification shall be used for the communication with system.

| Command code | Command Name | SMBus Transaction Type | Number of Data Bytes |
|---------------------|---------------------|-------------------------------|-----------------------------|
| 19h | CAPABILITY | READ BYTE | 1 |
| 1Ah | QUERY | READ BYTE | 1 |
| 88h | READ_ACV_IN | READ WORD | 2 |
| 89h | READ_ACI_IN | READ WORD | 2 |
| 8Bh | READ_VOUT | READ WORD | 2 |
| 8Ch | READ_IOUT | READ WORD | 2 |
| 8Dh | READ_TEMPERATURE_1 | READ WORD | 2 |
| 90h | READ_FAN1_SPEED | READ WORD | 2 |
| 91h | READ_FAN2_SPEED | READ WORD | 2 |
| 96h | READ_POUT | READ WORD | 2 |
| 97h | READ_PIN | READ WORD | 2 |
| 98h | PMBus_REVISION | READ BYTE | 1 |
| 99h | MFR_ID | R/W Block | 16 |
| 9Ah | MFR_MODEL | R/W Block | 16 |
| 9Bh | MFR_REVISION | R/W Block | 2 |
| 9Eh | MFR_SERIAL | R/W Block | 16 |
| A0h | MFR_VIN_MIN | READ WORD | 2 |
| A1h | MFR_VIN_MAX | READ WORD | 2 |
| A7h | MFR_POUT_MAX | READ WORD | 2 |
| B0h | USER_DATA_00 | READ BYTE | 1 |
| D0h | Reserved | | 2 |
| D1h | Reserved | | 2 |
| D2h | Reserved | | 2 |
| D3h | Reserved | | 2 |
| D4h | READ_AC_PFC | READ WORD | 2 |
| D5h | READ_AC_FREQUENC | READ WORD | 2 |

(Data Byte Type ASCII Code or HEX Code)

MFR-Manufacturer

| Command code | Command Name | Meaning | VALUE (ASCII or HEX CODE) |
|---------------------|---------------------|----------------|---|
| 19h | CAPABILITY | | 00H |
| 1Ah | QUERY | | F8H |
| 88h | READ_ACV_IN | 239.88 V | 5DH,B4H |
| 89h | READ_ACI_IN | 2.499 A | 09H,C3H |
| 8Bh | READ_VOUT | 12.100 V | 2FH,44H |
| 8Ch | READ_IOUT | 24.000 A | 5DH,C0H |
| 8Dh | READ_TEMPERATURE_1 | 38.5 °C | 01H,81H |
| 90h | READ_FAN_SPEED_1 | 12400 rpm | 30H,70H |
| 91h | READ_FAN_SPEED_2 | Reserved | 00H,00H |
| 96h | READ_POUT | 250.00 W | 61H,A8H |
| 97h | READ_PIN | 500.0 W | 01H,F4H |
| 98h | PMBus_REVISION | 1 | 01H |
| 99h | MFR_ID | KINTRON | 4BH,49H,4EH,54H,52H,4FH,4EH,20H,20H,20H,20H,20H,20H,20H,20H,20H |
| 9Ah | MFR_MODEL | RB1-G500HP | 52H,42H,31H,2DH,47H,35H,30H,30H,48H,50H,20H,20H,20H,20H |
| 9Bh | MFR_REVISION | A0 | 41H,30H |
| 9Eh | MFR_SERIAL_NO. | 201501010001 | 32H,30H,31H,35H,30H,31H,30H,31H,30H,30H,30H,31H,20H,20H,20H,20H |
| A0h | MFR_VIN_MIN | 100 VAC | 00H,64H |
| A1h | MFR_VIN_MAX | 240 VAC | 00H,F0H |
| A7h | MFR_POUT_MAX | 500W | 01H,F4H |
| B0h | USER_DATA_00 | Status Byte | 00H |
| D0h | Reserved | | |
| D1h | Reserved | | |
| D2h | Reserved | | |
| D3h | Reserved | | |
| D4h | READ_AC_PFC | 0.9999 | 27H,0FH |
| D5h | READ_AC_FREQUENC | 60.0HZ | 02H,58H |

(Data Byte Type ASCII Code or HEX Code)

Command code= B0h Command Name (USER_DATA_00)

| Bit Number | Status Bit Name | Meaning |
|------------|--------------------------|---------------------|
| 7 | Reserved | Default=0 |
| 6 | Reserved | Default=0 |
| 5 | Reserved | Default=0 |
| 4 | Reserved | Default=0 |
| 3 | Reserved | Default=0 |
| 2 | Reserved | Default=0 |
| 1 | PS_ON_Status | PS_OFF =0,PS_ON =1 |
| 0 | AC_Status (Must have12V) | AC OK =0,AC Fail =1 |

8.2.3. PMBus Command Protocol

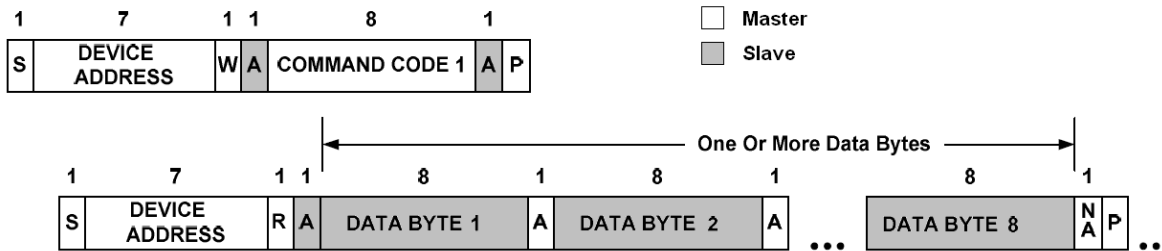

Command Protocol Without PEC

Figure 8.2.3-1

PMBus command protocol for the two steps (Figure 8.2.3-1). The first step is master device sends Device Address and Command Code1 to slave device. The Command Code 1 is set what kind data will receive on master device.

The second step is the master device will receive one or more DATA BYTE coming slave device.

8.2.4. PMBus signal connector

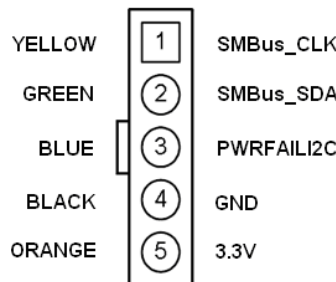

SMBus Signal Connector
5-PIN Molex 70545 or equivalent

9. Reliability

9.1 Mean time between failures (MTBF)

The MTBF of the power supply shall be calculated utilizing the Part-Stress Analysis method of MIL-217F or Bell core RPP. The calculated MTBF of the power supply shall be greater than 100,000 hours under the following conditions:

Full rated load

90V AC input

Ground Benign

25°C

9.2 Warranty

Three (3) years manufacture's warranty.

Technical information in this specification is subject to change without notice. The revision of specification will be marked on the cover.

10. Physical characteristics size

10.1 Dimension: 168mm(W) x 41.5mm(H) x 230mm(D)

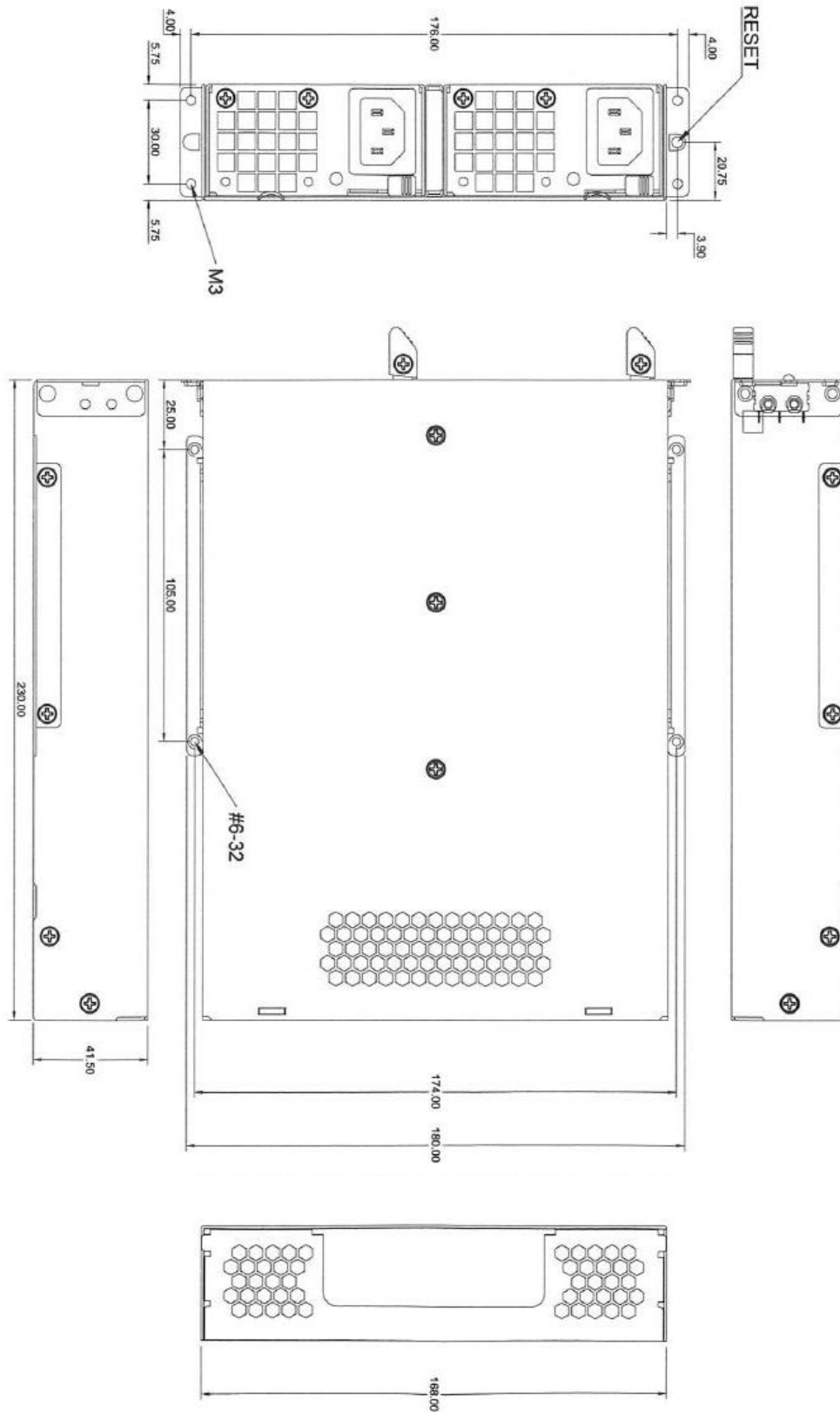

10.2 DC Output Wire

H6657R1-20-02A
Material: Nylon UL 94V-0 or UL 94V-2
Color: Natural
Electrical rating: 250V 5A, AC/DC
H6657R1-04-02B
Material: Nylon UL 94V-0 or UL 94V-2
Color: Natural
Electrical rating: 250V 5A, AC/DC

| | | | |
|-----------------|------------|----------------|------------|
| ORANGE | +3.3V | ORANGE/S,BROWN | +3.3V/3VS+ |
| ORANGE | +3.3V | BLUE | +12V |
| BLACK | GND | BLACK | GND |
| RED/S,RED | +5V/5VS+ | S,GREEN | PSON |
| BLACK | GND | BLACK | GND |
| RED | +5V | BLACK | GND |
| BLACK | GND | BLACK | GND |
| S,GRAY | PS | N/A | +5V |
| PURPLE | +5VSB | RED | -5V |
| YELLOW/S,YELLOW | +12V/12VS+ | RED | +5V |
| YELLOW | +12V3 | RED | +5V |
| ORANGE | +3.3V | BLACK | GND |

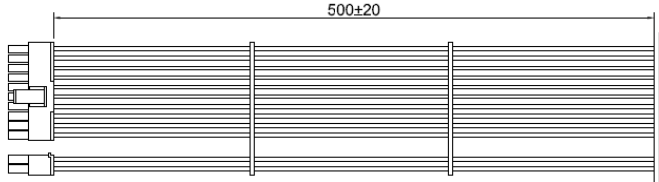

WST-P08-I42002
Material: Nylon 66 UL E149293 94V2
Color: Natural
Terminal: WST I42002PS-2A 250V AC/DC 9A

| | | | |
|-------|-----|--------|------|
| BLACK | GND | YELLOW | +12V |
| BLACK | GND | YELLOW | +12V |
| BLACK | GND | YELLOW | +12V |
| BLACK | GND | YELLOW | +12V |

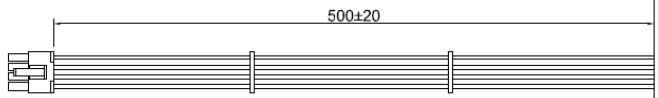

WST P6-I42002K13-B+P2-I42002K13-B
Material: Nylon UL 94V-0 or UL 94V-2
Color: Black
Electrical rating: 250V 5A, AC/DC

| | | | |
|--------|------|-------|-----|
| YELLOW | +12V | BLACK | GND |
| YELLOW | +12V | BLACK | GND |
| YELLOW | +12V | BLACK | GND |

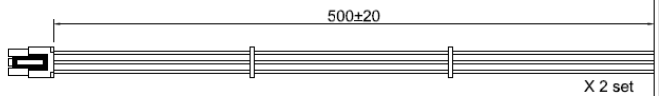

TKP H6657R1-4
Material: Nylon UL 94V-0 or UL 94V-2
Color: Natural
Electrical rating: 250V 5A, AC/DC

| | | | |
|-------|-----|--------|------|
| BLACK | GND | YELLOW | +12V |
| BLACK | GND | YELLOW | +12V |

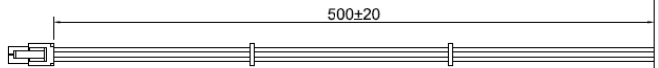

JMT JP1120-4
Material: Nylon PA66 UL 94-V2
Color: Natural
Electrical rating: 250V 10A, AC/DC
Terminal thickness: J1120BS-2A T=0.3mm

| | | | |
|--------|------|-------|-----|
| YELLOW | +12V | BLACK | GND |
| BLACK | GND | BLACK | GND |
| BLACK | GND | BLACK | GND |
| RED | +5V | BLACK | GND |

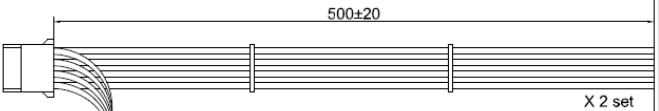

| | | | |
|--------|------|-------|-----|
| YELLOW | +12V | BLACK | GND |
| BLACK | GND | BLACK | GND |
| BLACK | GND | BLACK | GND |
| RED | +5V | BLACK | GND |



| | | | |
|--------|------|-------|-----|
| YELLOW | +12V | BLACK | GND |
| BLACK | GND | BLACK | GND |
| BLACK | GND | BLACK | GND |
| RED | +5V | BLACK | GND |

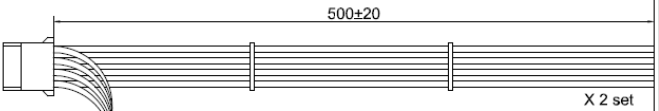

| | | | |
|--------|------|-------|-----|
| YELLOW | +12V | BLACK | GND |
| BLACK | GND | BLACK | GND |
| BLACK | GND | BLACK | GND |
| RED | +5V | BLACK | GND |



TKP H6657R1-4
Material: Nylon UL 94V-0 or UL 94V-2
Color: Natural
Electrical rating: 250V 5A, AC/DC

| | | | |
|--------|------|-------|-----|
| YELLOW | +12V | BLACK | GND |
| BLACK | GND | BLACK | GND |
| BLACK | GND | BLACK | GND |
| RED | +5V | BLACK | GND |

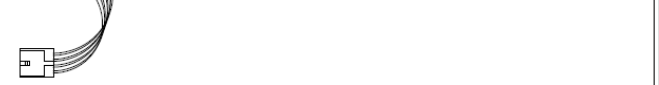

MOLEX 675820000 or equivalent
Material: Nylon UL 94V-0 or UL 94V-2
Color: Black
Electrical rating: 30V 8.3A, AC/DC

| | | | |
|--------|-------|-------|-----|
| YELLOW | +12V | BLACK | GND |
| BLACK | GND | BLACK | GND |
| RED | +5V | BLACK | GND |
| ORANGE | +3.3V | BLACK | GND |

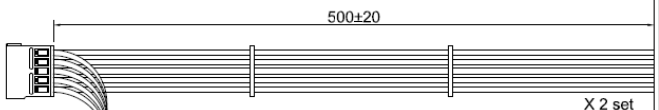

| | | | |
|--------|-------|-------|-----|
| YELLOW | +12V | BLACK | GND |
| BLACK | GND | BLACK | GND |
| RED | +5V | BLACK | GND |
| ORANGE | +3.3V | BLACK | GND |



WST P5-I25402
Material: Nylon 66 UL E149293 94V0
Color: Black
Terminal: WST I25402PS-2 250V AC/DC 3A

| | |
|--------|--|
| ORANGE | |
| BLACK | |
| BLUE | |
| GREEN | |
| YELLOW | |

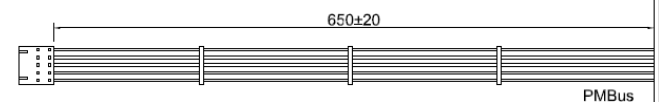

TKP 2510; 2 Circuits, 2.54mm
Material: Nylon UL 94V0
Color: White
Electrical rating: 250V 2A, AC/DC

| | |
|--------|--|
| BLACK | |
| ORANGE | |

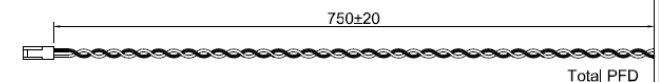

10.3 Module PIN Assignment

