

# SPECIFICATION

Model: **RB2-G460VP**

Redundant Power Supply

Active PFC

460W + 460W

80+ Gold Efficiency

PMBus 1.2

Approve	Check	Prepare
Brian	Richard	Vincent

## Release History

<b>Rev.</b>	<b>Description</b>	<b>Date</b>	<b>Name</b>
X01	Initial draft release	2014/08/01	Vincent
X02	Modify Output Rating	2014/10/15	Vincent
X03	Modify Operating Temperature Range	2014/11/13	Vincent
X04	Modify model name & Efficiency	2014/12/09	Vincent
A	The final version - Modify Output Rating & Efficiency	2015/01/15	Vincent

## Contents

1.	General	5
2.	AC input pacifications	5
2.1	AC input voltage, frequency and current	5
2.2	AC inrush current	6
2.3	Input power factor correction (Active PFC)	6
2.4	Input current harmonics	6
2.5	Drop out	6
3.	DC output specification	7
3.1	Output current / loading	7
3.2	DC voltage regulation, ripple and noise	7
3.3	Timing requirements	8
3.4	Remote On/Off control PSON#	9
3.5	Efficiency	10
3.6	+5VSB (Standby)	10
4.	Protection	11
4.1	Over power protection	11
4.2	Over voltage protection	11
4.3	Over current protection	11
4.4	Short circuit protection	12
5.	Environmental requirements	12
5.1	Temperature	12
5.2	Humidity	12
6.	Agency requirement	12
6.1	Safety certification	12
6.2	AC input leakage current	12
7.	Redundant power supply function	13
7.1	Redundancy	13
7.2	Hot swap requirements	13
7.3	LED indicators	14
8.	PMBus (Option)	14
8.1	PMBus communication	14
8.2	Power supply management interface	14
8.3	PMBus signal connector	17

9.	Reliability	18
9.1	Mean Time Between failures (MTBF)	18
9.2	Warranty	18
10.	Physical characteristics size	19
10.1	Dimension: 82(W) x 84m(H) x 217(D)	19
10.2	DC Output Wire	20
10.3	Module PIN Assignment	21

## 1. General

This is the specification of Model RB2-S460VP; it is intended to describe the functions and performance of the redundant power supply. The RB2-S460VP 460 watts redundant power supply is featured with Active PFC (Power Factor Correction) capability and Gold efficiency for 80+ and PMBus function meets IEC61000-3-2 and equips full range Input features.

Base on the KINTRON Product coding rule, you could quickly figure out the description by following:

1 2 3 4 5 6 7  
**R B 2 - G 460 V P**

1. Power type: M: mini redundant, R: redundant, S: single, U: unit/module.
2. Size type: From A to Z and each one has its own dimension.
3. Height/PS2: for redundant power mean the height of the set 1: 1U, 2: 2U, 3: 3U, 4: 4U, P: PS2.
4. Efficiency: Base on 80+ definition, B: Bronze, S: Silver, G: Gold, P: Platinum, T: Titanium.
5. DC output watt: The total power for power supply and use three digit as naming, 550: 550W, 600: 600W, A00:1000W, B00:1100W... etc.
6. Application dimension: H: Horizontal, V: Vertical.
7. PMBus: P: with PMBus, N: without PMBus.

## 2. AC input specifications

### 2.1 AC input voltage, frequency and current (Rating: 100V-240 VAC, 47-63Hz, 8.5-4A)

The power supply must operate within all specified limits over the input voltage range in Table 1. Harmonics distortion of up to 10% THD must not cause the power supply to go out of specified limits.

Base on the minimum voltage and power transfer, the max current calculation as below:

$$\text{Max Current} \geq (\text{Watt} / \text{Efficiency}) / \text{Minimum Voltage}$$

Parameter	Minimum	Normal	Maximum	Max. Current
Voltage (115V)	90 VAC	100-120 VAC	132 VAC	8.5A
Voltage (230V)	180 VAC	200-240 VAC	264 VAC	4A
Frequency	47 Hz	50 / 60 Hz	63 Hz	N/A

Table 1 – AC Input Voltage and Frequency

## 2.2 AC inrush current

The power supply must meet inrush requirements of any rated AC voltage, during turn on at any phase of voltage, during a single cycle AC dropout condition, during repetitive On/Off cycling of AC, and over the specified temperature range. The peak inrush current shall be 30/60A @ 115/230 VAC (25°C) per module when cold start and less than the rating of its critical components (including input fuse, bulk rectifiers, and surge limiting device).

## 2.3 Input power factor correction (Active PFC)

The power factor at 50% load shall be  $\geq 0.9$  at 230V input voltage.

## 2.4 Input current harmonics

When the power supply is operated in 90-264 VAC of Sec. 2.1, the input harmonic current drawn on the power line shall not exceed the limits set by FCC Class B and GB9254-200 standards. The power supply shall incorporate universal power input with active power factor correction.

## 2.5 Dropout

An AC line dropout of 17mS or less shall not cause any tripping of control signals or protection circuits. If the AC dropout lasts longer than 17mS, the power supply should recover and meet all turn on requirements. The power supply shall meet the regulation requirement over all rated AC voltages, frequencies, and output loading conditions. Any dropout of the AC line shall not cause damage to the power supply. An AC line dropout is defined as a drop in AC line to 0 VAC at any phase of the AC line for any length of time.

### 3. DC output specification

#### 3.1 Output current / loading

The following table defines power and current rating. The power supply shall meet both static and dynamic voltage regulation requirements for minimum load condition.

Output Voltage	+5V	+3.3V	+12V	-12V	+5VSB
Max. Load	24A	24A	38A	0.8A	2.5A
Min. Load	1A	1A	1A	0A	0.1A
Max. Combined	160W			9.6W	12.5W
Total Output	460W				

Table 2 – Output Loads Range 1

Note 1: Maximum continuous total DC output power should not exceed 460W.

#### 3.2 DC voltage regulation, ripple and noise

The power supply output voltages must stay within the following voltage limits when operating at steady state and dynamic loading conditions. All outputs are measured with reference to the return remote sense (Returns) signal. The +5V, +3.3V, +12V, -12V and +5VSB outputs are measure at the power supply connectors references to Returns. The +5V and +3.3V is measured at its remote sense signal (+5VS, +3.3VS) located at the signal connector.

Output Voltage	+5V	+3.3V	+12V	-12V	+5VSB
Load Reg.	+/-5%	+/-5%	+/-5%	+/-5%	+/-5%
Line Reg.	+/-1%	+/-1%	+/-1%	+/-1%	+/-1%
Ripple & Noise	50mV	50mV	120mV	120mV	50mV

Table 3 – Regulation, ripple and noise

Ripple and Noise shall be measured using the following methods:

- a) Measurements made differentially to eliminate common-mode noise.
- b) Ground lead length of oscilloscope probe shall be 0.25 inch.
- c) Measurements made where the cable connectors attach to the load.
- d) Outputs bypassed at the point of measurement with a parallel combination of 10uF tantalum capacitor in parallel with a 0.1uF ceramic capacitors.
- e) Oscilloscope bandwidth of 0 Hz to 20MHz.
- f) Measurements measured at locations where remote sense wires are connected.
- g) Regulation tolerance shall include temperature change, warm up drift and dynamic load.

### 3.3 Timing requirements

These are the timing requirements for the power assembly operation. The output voltages must rise from 10% to within regulation limits ( $T_{vout\_rise}$ ) within 5 to 70mS. The +5V, +3.3V and +12V output voltages should start to rise at about the same time. All outputs must rise monotonically. The +5V output must occur first than the +3.3V output during any point of the voltage rise. The +5V output must never be greater than the +3.3V output by more than 2.25V. Each output voltage shall reach regulation within 50 ms ( $T_{vout\_on}$ ) of each other during turn on of the power supply. Each output voltage shall fall out of regulation within 400 mS ( $T_{vout\_off}$ ) of each other during turn off. Figure 1 and figure 2 shows the turn on and turn off timing requirement. In Figure 2, the timing is shown with both AC and PSON# controlling the on/off of the power supply.

Item	Description	MIN	MAX	Units
$T_{vout\_rise}$	Output voltage rise time from each main output.(+5Vsb < 70mS)	5	70	mS
$T_{vout\_on}$	All main output must be within regulation of each other within this time.	N/A	50	mS
$T_{vout\_off}$	All main output must leave regulation within this time	N/A	400	mS

Table 4 – Output Voltage Timing

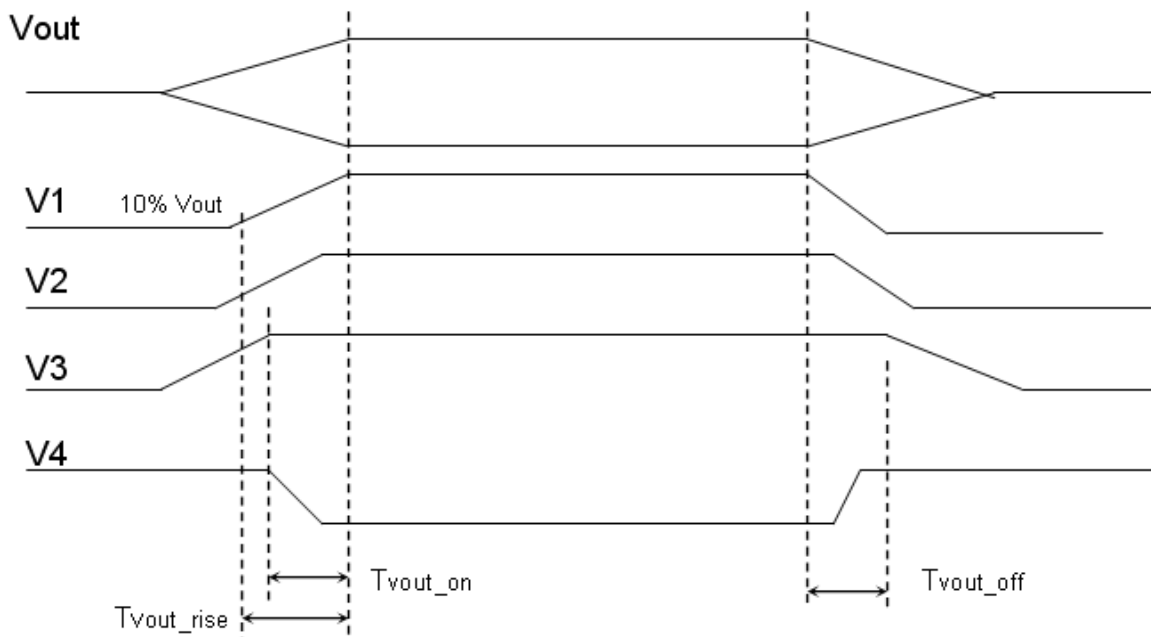

Figure 1 – Voltage Output Timing



Item	Description	MIN	MAX	Units
Tsb_on-delay	Delay from AC being applied to +5VSB is being within regulation.	N/A	1500	mS
Tac_on-delay	Delay from AC being applied to all output voltages being Within regulation.	N/A	2500	mS
Tvout_holdup	All main output voltage stay within regulation after loss of AC	18	N/A	mS
Tpwok_holdup	Delay from loss of AC deassertion of PWOK.	17	N/A	mS
Tpson_on_delay	Delay from PSON# active to output voltage within regulation limits.	5	400	mS
Tpson_pwok	Delay from PSON# deactive to PWOK being deasserted.	N/A	50	mS
Tpwok_on	Delay from output voltage within regulation limits to PWOK asserted at turn on.	100	500	mS
Tpwok_off	Delay from PWOK deasserted to output voltages (+5V, +3.3V, +12V) dropping out of regulation limits.	1	N/A	mS
Tpwok_low	Duration of PWOK being in the deasserted state during an off/on cycle using AC or the PSON# signal. .	100	N/A	mS
Tsb_vout	Delay from +5VSB being in regulation to O/Ps being in regulation at AC turn on.	50	1000	mS

Table 5 – Turn On/Off Timing

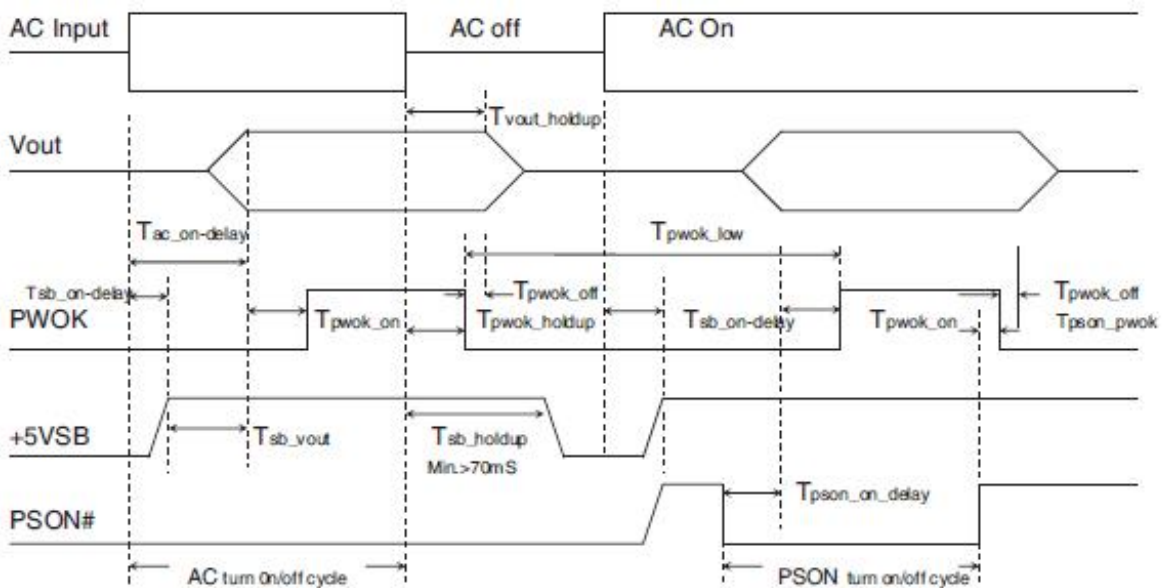

Figure 2 – Turn On/Off Timing

### 3.4 Remote On/Off Control: PSON#

The PSON# signal is required to remotely turn on/off the power supply. PSON# is an active low signal that turns on the +5V, +3.3V, +12V, -5V and -12V power rails. When this signal is not pulled low by the system, or left open, the outputs (except the +5VSB and V bias) turn off. This signal is pulled to a standby voltage by a pull-up resistor internal to the power supply.

Signal Type	Accepts an open collector/drain input from the system. Pull-up to VSB located in power supply.
PSON# = Low	Power ON
PSON# = High	Power OFF

**Table 6 – PWOK Signal Characteristic**

### 3.5 Efficiency (80+ Gold)

The efficiency should be measured module at 230 VAC and with external fan power source at specified loading.

Input Voltage	20% Load	50% Load	100% Load
230 VAC	88%	92%	88%

Reference [www.80plus.org](http://www.80plus.org) all test conditions.

### 3.6 +5VSB (Standby)

The +5VSB output is always on (+5V Standby) when AC power is applied and power switch is turned on. The +5VSB line is capable of delivering at a maximum of 3A for PC board circuit to operate.

## 4. Protection

Protection circuits inside the power supply shall cause only the power supply's main outputs to shutdown. If the power supply latches off due to a protection circuit tripping, either an AC cycle OFF for 15 sec or PSON #cycle HIGH for 1 sec must be able to restart the power supply.

### 4.1 Over power protection

The OPP function shall work at 110%~160% of rating of output power, then all outputs shut down in a latch off mode. The latch shall be cleared by toggling the PSON# signal or by cycling the AC power. The power supply shall not be damaged from repeated power cycling in this condition. If only one module works inside the power supply, the OPP is at 110%~160% of rating of power supply.

### 4.2 Over voltage protection

Each hot swap module has respective OVP circuit. Once any power supply module shut down in a latch off mode while the output voltage exceeds the over voltage limit shown in Table 7, the other modules should deliver the sufficient power to the device continually.

Voltage	Minimum	Maximum	Shutdown Mode
+5V	+5.7V	+6.5V	Latch Off
+3.3V	+3.9V	+4.5V	Latch Off
+12V	+13.3V	+14.5V	Latch Off
5VSB	+5.7V	+6.5V	Auto recovery

Table 7 –Over Voltage protection

### 4.3 Over current protection

The power supply should contain the OCP function on each hot swap module. The power supply should be shut down in a latch off mode while the respective output current exceeds the limit as shown in Table 8. When the latch has been cleared by toggling the PSON# single or cycling the AC input power. The power supply module should not be damaged in this condition.

Voltage	Minimum	Maximum	Shutdown Mode
+5V	110%	170%	Latch Off
+3.3V	110%	170%	Latch Off
+12V	110%	170%	Latch Off

Table 8 –Over Current protection

#### 4.4 Short circuit protection

The power supply shall shut down in a latch off mode when the output voltage is short circuit.

### 5. Environmental requirements

#### 5.1 Temperature

Operating Temperature Range:	0°C ~ 45°C (32°F~ 113°F)
Non-Operating Temperature Range:	-20°C ~ 70°C (-4°F~ 158°F)

#### 5.2 Humidity

Operating Humidity Range:	20% ~ 90%RH non-condensing
Non-Operating Humidity Range:	5% ~ 95%RH non-condensing

### 6. Agency requirements

#### 6.1 Safety **(Planning)**

Product Safety:	<ul style="list-style-type: none"> <li>UL60950-1/CSA 60950 (USA/Canada)</li> <li>TÜV (CB) IEC60950 (report to include all country national deviations)</li> <li>EN60950-1(Europe)/IEC60950-1(International)</li> <li>CCC- CNCA Certification (China)</li> <li>BSMI(Taiwan)</li> <li>FCC(USA)</li> <li>CE-low voltage directive 2006/95/EC(Europe)</li> </ul>
-----------------	--

#### 6.2 AC Input leakage current

Input leakage current from line to ground will be less than 3.5mA rms. Measurement will be made at 240 VAC and 60Hz.

## 7. Redundant power supply function

### 7.1 Redundancy

The redundant power supply is  $N+1=N$  ( $460W+460W=460W$ ) function power supply, each one module is redundancy when any one module was failed. To be redundant each item must be in the hot swap power supply module.

### 7.2 Hot swap requirements

The redundant power supply modules shall be hot swappable. Hot swapping a power supply is the process of inserting and extracting a power supply from an operating. During this process the output voltage shall remain within the limits specified in Table 7 with the capacitive load specified Table 9. The Sub-system shall not exceed the maximum inrush current as specified in section 2.2. The power supply can be hot swapped by the following methods:

AC connects with each module. Up to two power supplies may be on a single AC power source. Extraction: The AC power will be disconnected from the power supply first and then the power supply is extracted from the sub-system. This could occur in standby mode or powered on mode. Insertion: The module is inserted into the cage and then AC power will be connected to the power supply module.

For power modules with AC docking at the same time as DC. Extraction: The module is extracted from the cage and both AC and DC disconnect at the same Time. This could occur in standby or power on mode. No damage or arcing shall occur to the DC or AC contacts which could cause damage. Insertion: The AC and DC connect at the same time as the module is inserted into the cage. No damage to the connector contacts shall occur. The module may power on or come up into standby mode.

Many variations of the above are possible. Supplies need to be compatible with these different variations depending upon the sub-system construction. In general, a failed (off by internal latch or external control) supply may be removed, then replaced with a good power supply (must use the same model); however, hot swap needs to work with operational as well as failed power supplies. The newly inserted power supply may get turned on by inserting the supply into the system or by system management recognizing an inserted supply and explicitly turning it on.

### 7.3 LED Indicators

There is a single bi-color LED to indicate the power supply status. The Green LED turn ON to indicate that all the power outputs are available. The Orange LED (Green+Red) turn ON to indicate that the power supply has stand-by or failed shutdown due to over current, the Red LED turn ON to indicate the Fan of the power supply has failed. The LED(s) shall be visible on the exterior face of the power supply. The LED location shall meet ESD requirements. LED shall be securely mounted in such a way that incidental pressure on the LED shall not cause displaced.

## 8. PMBus

### 8.1 PMBus communication

The PMBus serial bus communication devices for I2C data in the power supply shall be compatible with both SMBus 2.0 “high power” and I2C Vdd based power and drive. This bus shall operate at 3.3V but tolerant of 5V signaling. The SMBus pull-ups are located on the motherboard and may be connected to 3.3V or 5V.

Two pins are allocated on the power supply. One pin is the serial clock (SMBus\_SCL). The second pin is used for serial data (SMBus\_SDA). Both pins are bi-directional and are used to form a serial bus.

The device(s) in the power supply shall be located at an address(s) determined by addressing pins A0 and A1 on the power supply module. The circuits inside the power supply shall derive their power from the 5VSB bus. Device(s) shall be powered from the system side of the 5VSB device. No pull-up resistors shall be on SCL or SDA inside the power supply. There pull-up resistors should be located external to the power supply.

### 8.2 Power supply management interface

The device in the power supply shall derive its power off of the 5VSB output on the system side. It shall be located at an address set by the A0 and A1 pins. Refer to the PMBus specification posted on the [www.powerSIG.org](http://www.powerSIG.org) website for details on the power supply monitoring interface requirements. I2C is a SMBus interface used to communicate power management information to the system.

#### 8.2.1. Power supply management interface address

Device address locations

	Housing	M1	M2
PDB addressing A1/A0		1/1	0/1
Device Address		B0h	B2h

#### 8.2.2. PMBus command code summary

### 8.2.2. PMBus command code summary

PMBus Revision1.2 specification shall be used for the communication with system.

Command code	Command Name	SMBus Transaction Type	Number of Data Bytes
19h	CAPABILITY	READ BYTE	1
1Ah	QUERY	READ BYTE	1
88h	READ_ACV_IN	READ WORD	2
89h	READ_ACI_IN	READ WORD	2
8Bh	READ_VOUT	READ WORD	2
8Ch	READ_IOUT	READ WORD	2
8Dh	READ_TEMPERATURE_1	READ WORD	2
90h	READ_FAN1_SPEED	READ WORD	2
91h	READ_FAN2_SPEED	READ WORD	2
96h	READ_POUT	READ WORD	2
97h	READ_PIN	READ WORD	2
98h	PMBus_REVISION	READ BYTE	1
99h	MFR_ID	R/W Block	16
9Ah	MFR_MODEL	R/W Block	16
9Bh	MFR_REVISION	R/W Block	2
9Eh	MFR_SERIAL	R/W Block	16
A0h	MFR_VIN_MIN	READ WORD	2
A1h	MFR_VIN_MAX	READ WORD	2
A7h	MFR_POUT_MAX	READ WORD	2
B0h	USER_DATA_00	READ BYTE	1
D0h	Reserved		2
D1h	Reserved		2
D2h	Reserved		2
D3h	Reserved		2
D4h	READ_AC_PFC	READ WORD	2
D5h	READ_AC_FREQUENC	READ WORD	2

(Data Byte Type ASCII Code or HEX Code)

**MFR-Manufacturer**

<b>Command code</b>	<b>Command Name</b>	<b>Meaning</b>	<b>VALUE ( ASCII or HEX CODE )</b>
19h	CAPABILITY		00H
1Ah	QUERY		F8H
88h	READ_ACV_IN	239.88 V	5DH,B4H
89h	READ_ACI_IN	2.499 A	09H,C3H
8Bh	READ_VOUT	12.100 V	2FH,44H
8Ch	READ_IOUT	24.000 A	5DH,C0H
8Dh	READ_TEMPERATURE_1	38.5 °C	01H,81H
90h	READ_FAN_SPEED_1	12400 rpm	30H,70H
91h	READ_FAN_SPEED_2	Reserved	00H,00H
96h	READ_POUT	250.00 W	61H,A8H
97h	READ_PIN	460.0 W	0FH,A0H
98h	PMBus_REVISION	1	01H
99h	MFR_ID	KINTRON	4BH,49H,4EH,54H,52H,4FH,4EH,20H,20H,20H,20H,20H,20H,20H,20H,20H
9Ah	MFR_MODEL	RB2-G460VP	52H,42H,32H,2DH,47H,34H,36H,30H,56H,50H,20H,20H,20H,20H
9Bh	MFR_REVISION	A0	41H,30H
9Eh	MFR_SERIAL_NO.	201501010001	32H,30H,31H,35H,30H,31H,30H,3H,30H,30H,30H,31H,20H,20H,20H,20H
A0h	MFR_VIN_MIN	100 VAC	00H,64H
A1h	MFR_VIN_MAX	240 VAC	00H,F0H
A7h	MFR_POUT_MAX	460W	01H,CCH
B0h	USER_DATA_00	Status Byte	00H
D0h	Reserved		
D1h	Reserved		
D2h	Reserved		
D3h	Reserved		
D4h	READ_AC_PFC	0.9999	27H,0FH
D5h	READ_AC_FREQUENC	60.0HZ	02H,58H

(Data Byte Type ASCII Code or HEX Code)



Command code= B0h Command Name (USER\_DATA\_00)

Bit Number	Status Bit Name	Meaning
7	Reserved	Default=0
6	Reserved	Default=0
5	Reserved	Default=0
4	Reserved	Default=0
3	Reserved	Default=0
2	Reserved	Default=0
1	PS_ON_Status	PS_OFF =0,PS_ON =1
0	AC_Status (Must have12V)	AC OK =0,AC Fail =1

### 8.2.3. PMBus Command Protocol

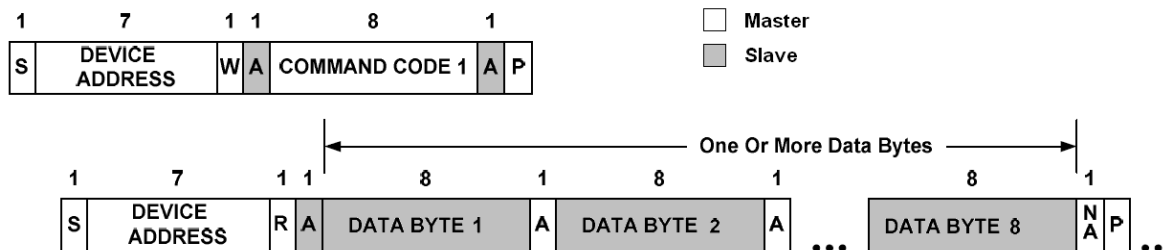

**Command Protocol Without PEC**

Figure 8.2.3-1

PMBus command protocol for the two steps (Figure 8.2.3-1). The first step is master device sends Device Address and Command Code1 to slave device. The Command Code 1 is set what kind data will receive on master device.

The second step is the master device will receive one or more DATA BYTE coming slave device.

### 8.2.4. PMBus signal connector

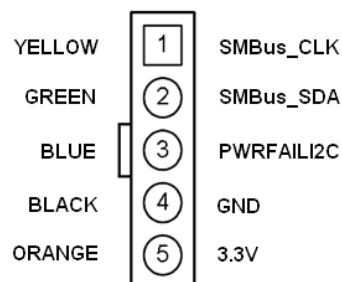

SMBus Signal Connector  
5-PIN Molex 70545 or equivalent

## 9. Reliability

### 9.1 Mean time between failures (MTBF)

The MTBF of the power supply shall be calculated utilizing the Part-Stress Analysis method of MIL-217F or Bell core RPP. The calculated MTBF of the power supply shall be greater than 100,000 hours under the following conditions:

**Full rated load**

**90V AC input**

**Ground Benign**

**25°C**

### 9.2 Warranty

Three (3) years manufacture's warranty.

Technical information in this specification is subject to change without notice. The revision of specification will be marked on the cover.

## 10. Physical characteristics size

### 10.1 Dimension: 82(W) x 84m(H) x 217(D)

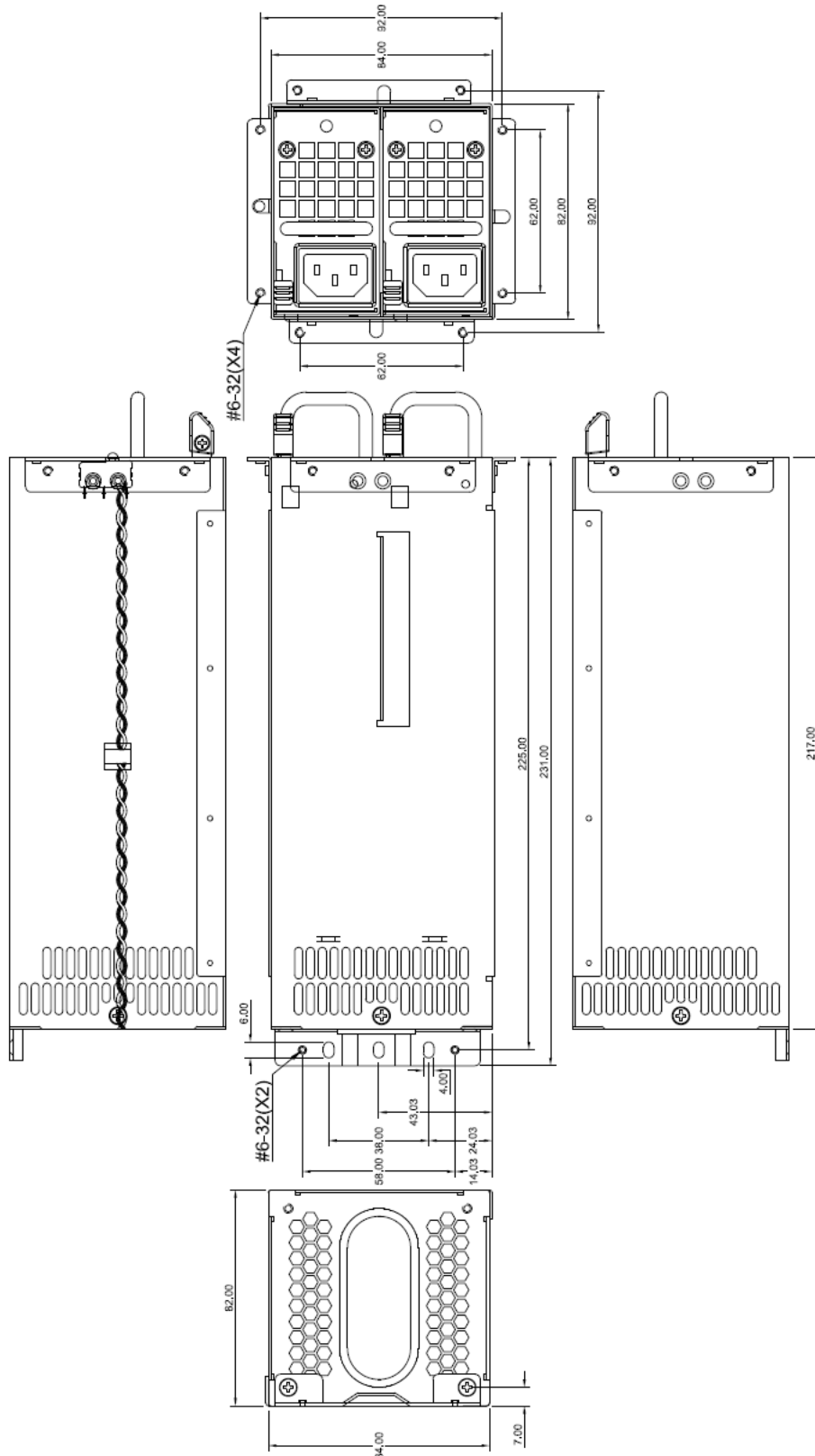

## 10.2 DC Output Wire

H6657R1-20-02A  
 Material: Nylon UL 94V-0 or UL 94V-2  
 Color: Natural  
 Electrical rating: 250V 5A, AC/DC  
 H6657R1-04-02B  
 Material: Nylon UL 94V-0 or UL 94V-2  
 Color: Natural  
 Electrical rating: 250V 5A, AC/DC

ORANGE	+3.3V		ORANGE/S,BROWN	+3.3V/3VS+
ORANGE	+3.3V		BLUE	+12V
BLACK	GND		BLACK	GND
RED/S,RED	+5V/5VS+		S,GREEN	P50N
BLACK	GND		BLACK	GND
RED	+5V		BLACK	GND
BLACK	GND		BLACK	GND
S,GRAY	P5		N/A	+5V
PURPLE	+5VSB		RED	-5V
YELLOW/S,YELLOW	+12V3/12VS+		RED	+5V

YELLOW	+12V3		RED	+5V
ORANGE	+3.3V		BLACK	GND

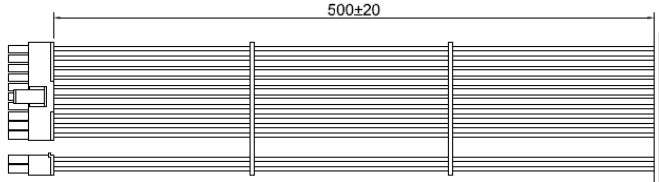

WST-P08-I42002  
 Material: Nylon 66 UL E149293 94V2  
 Color: Natural  
 Terminal: WST I42002PS-2A 250V AC/DC 9A

BLACK	GND		YELLOW	+12V
BLACK	GND		YELLOW	+12V
BLACK	GND		YELLOW	+12V
BLACK	GND		YELLOW	+12V

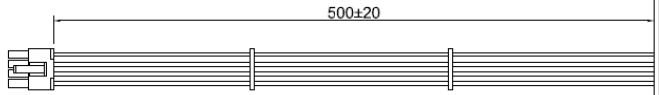

WST P6-I42002K13-B+P2-I42002K13-B  
 Material: Nylon UL 94V-0 or UL 94V-2  
 Color: Black  
 Electrical rating: 250V 5A, AC/DC

YELLOW	+12V		BLACK	GND
YELLOW	+12V		BLACK	GND
YELLOW	+12V		BLACK	GND

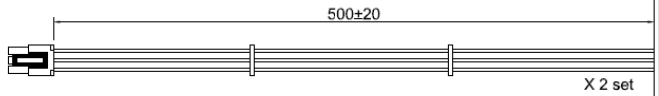

TKP H6657R1-4  
 Material: Nylon UL 94V-0 or UL 94V-2  
 Color: Natural  
 Electrical rating: 250V 5A, AC/DC

BLACK	GND		YELLOW	+12V
BLACK	GND		YELLOW	+12V

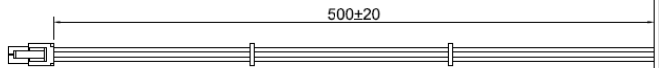

JMT JP1120-4  
 Material: Nylon PA66 UL 94-V2  
 Color: Natural  
 Electrical rating: 250V 10A, AC/DC  
 Terminal thickness: J1120BS-2A T=0.3mm

YELLOW	+12V		BLACK	GND
BLACK	GND		BLACK	GND
BLACK	GND		BLACK	GND
RED	+5V		BLACK	GND

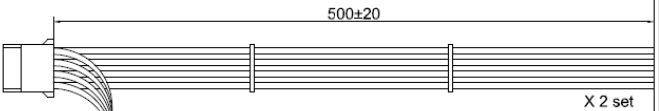

YELLOW	+12V		BLACK	GND
BLACK	GND		BLACK	GND
BLACK	GND		BLACK	GND
RED	+5V		BLACK	GND



YELLOW	+12V		BLACK	GND
BLACK	GND		BLACK	GND
BLACK	GND		BLACK	GND
RED	+5V		BLACK	GND

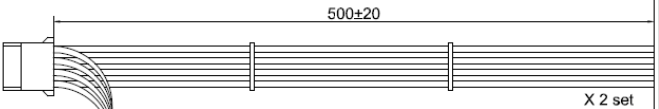

YELLOW	+12V		BLACK	GND
BLACK	GND		BLACK	GND
BLACK	GND		BLACK	GND
RED	+5V		BLACK	GND



TKP H6657R1-4  
 Material: Nylon UL 94V-0 or UL 94V-2  
 Color: Natural  
 Electrical rating: 250V 5A, AC/DC

YELLOW	+12V		BLACK	GND
BLACK	GND		BLACK	GND
BLACK	GND		BLACK	GND
RED	+5V		BLACK	GND



MOLEX 675820000 or equivalent  
 Material: Nylon UL 94V-0 or UL 94V-2  
 Color: Black  
 Electrical rating: 30V 8.3A, AC/DC

YELLOW	+12V		BLACK	GND
BLACK	GND		BLACK	GND
RED	+5V		BLACK	GND
ORANGE	+3.3V		BLACK	GND

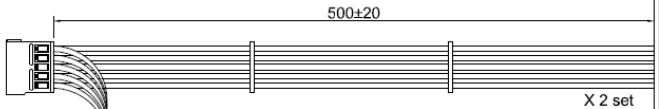

YELLOW	+12V		BLACK	GND
BLACK	GND		BLACK	GND
RED	+5V		BLACK	GND
ORANGE	+3.3V		BLACK	GND



WST P5-I25402  
 Material: Nylon 66 UL E149293 94V0  
 Color: Black  
 Terminal: WST I25402PS-2 250V AC/DC 3A

ORANGE	
BLACK	
BLUE	
GREEN	



TKP 2510; 2 Circuits, 2.54mm  
 Material: Nylon UL 94V0  
 Color: White  
 Electrical rating: 250V 2A, AC/DC

BLACK	
ORANGE	

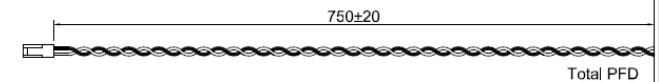

### 10.3 Module PIN Assignment

